

1

Put the frame together

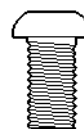
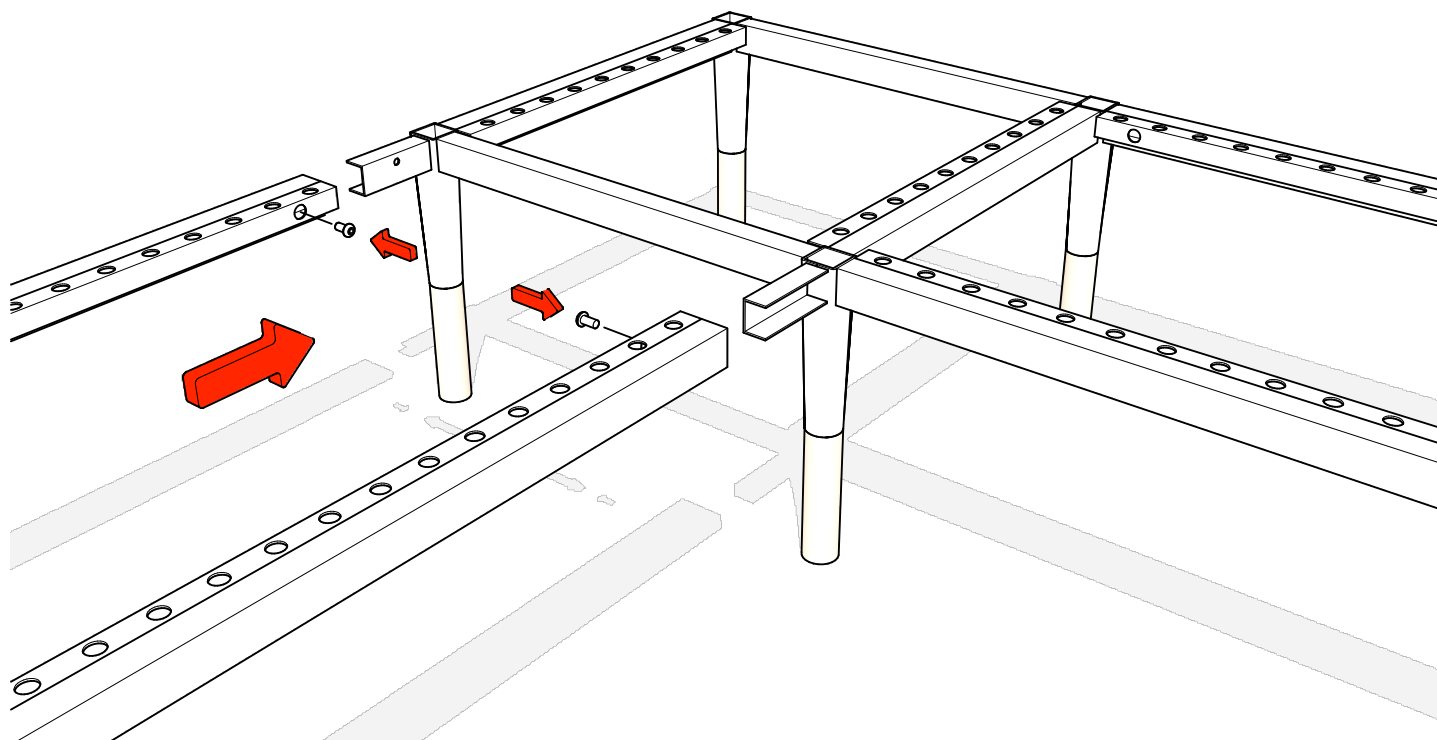

M6 x 12 mm

JOHANSON

2

Each seat element is numbered 1,2,3 etc., facing the sofa, start with number 1 from the right side

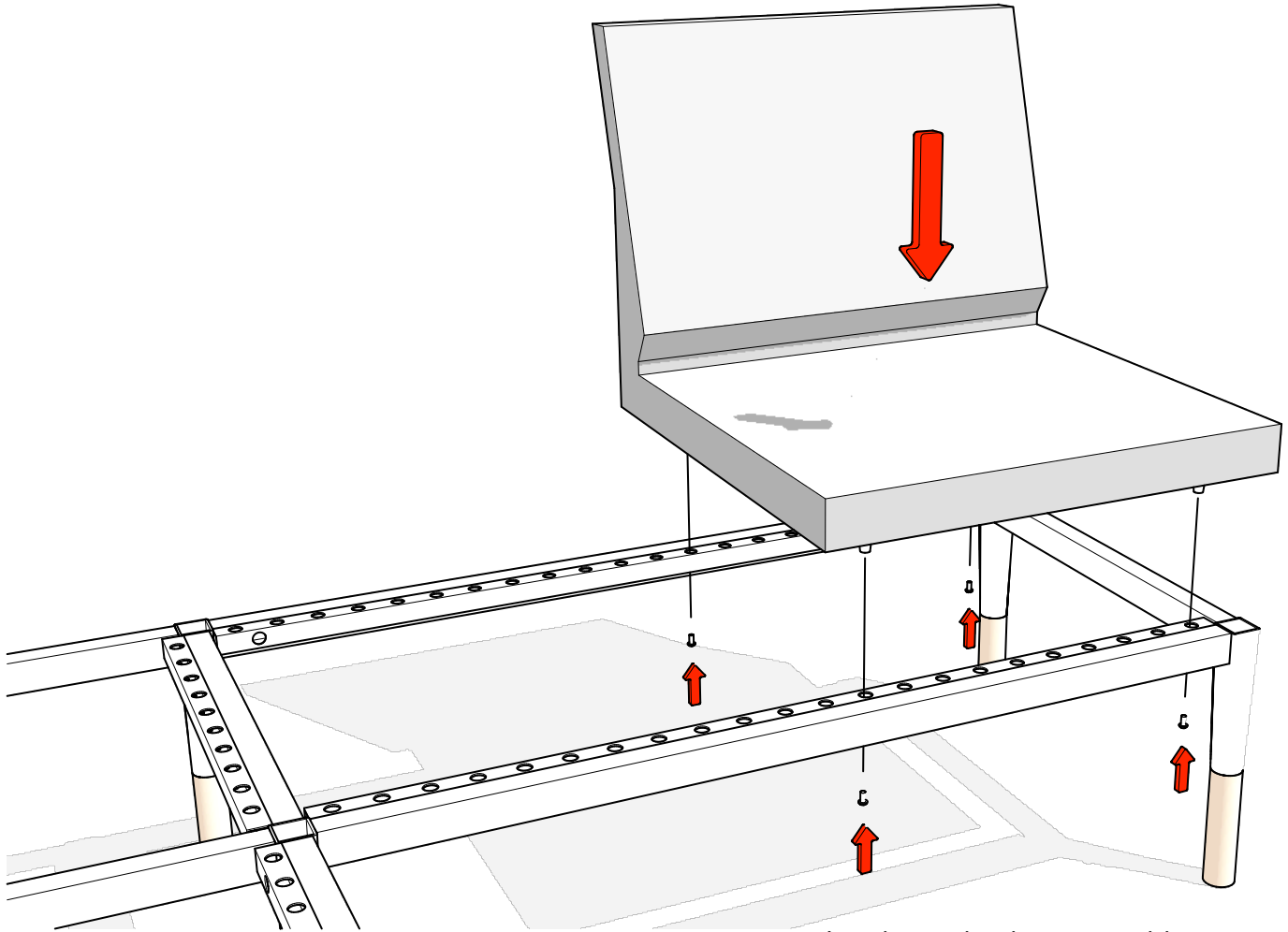

Lock each element with four screws

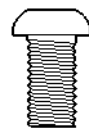

M6 x 12 mm

JOHANSON

3

Fix hook in seat elementt

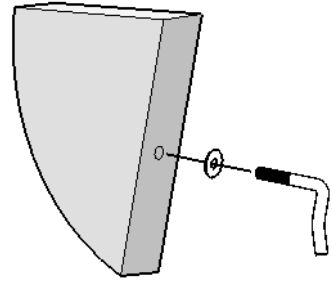

Hook the element into the fixed element

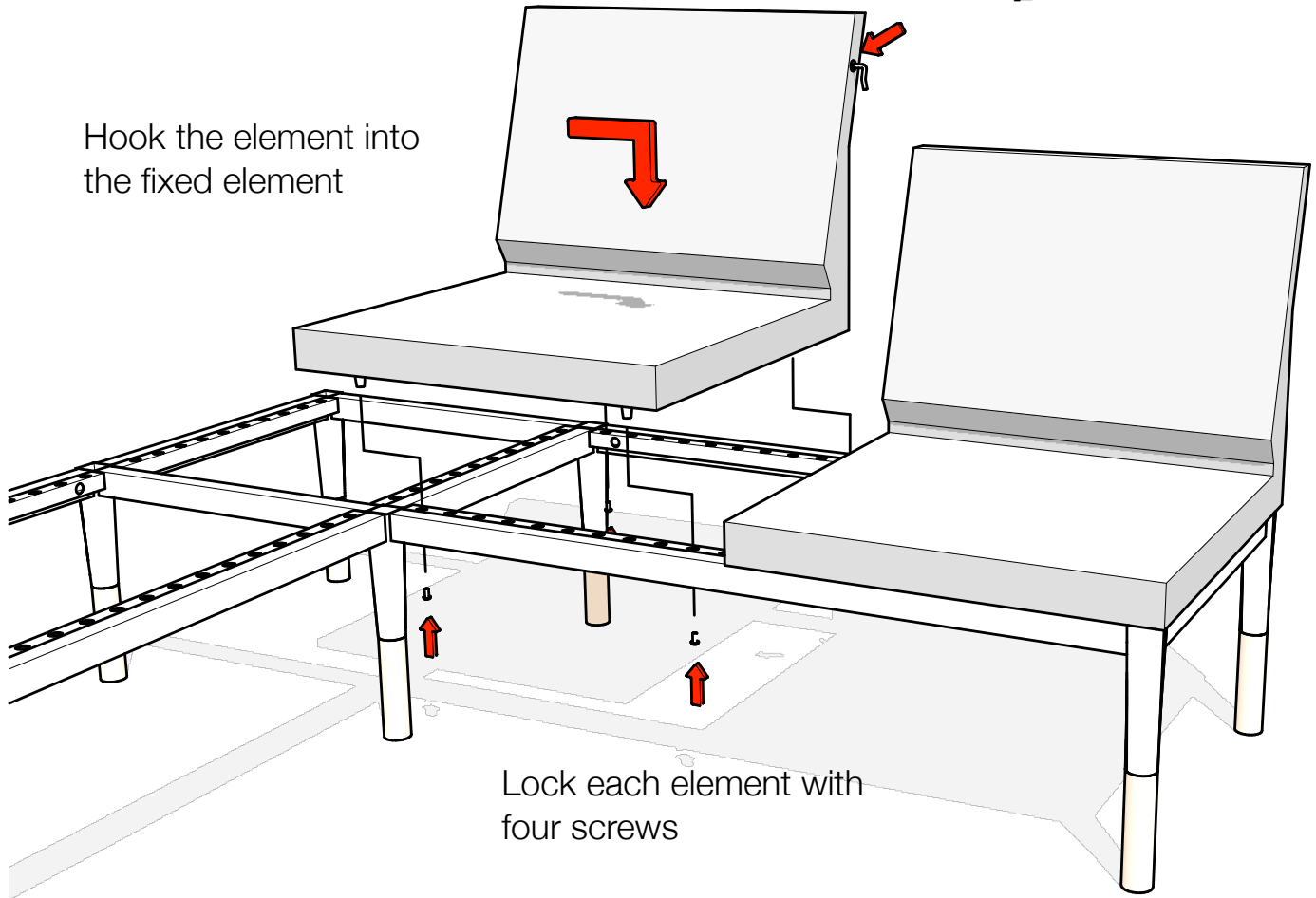

Lock each element with four screws

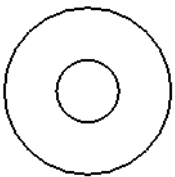

ø8 x ø22 x 1,5 mm

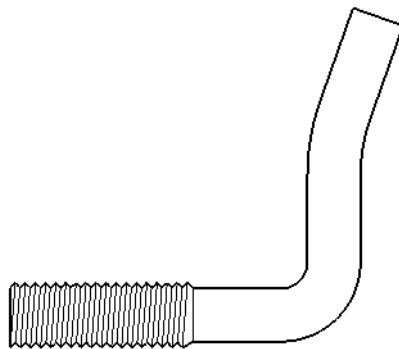

Hook M8 x 25 mm

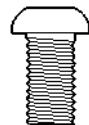

M6 x 12 mm

JOHANSON

4

Fix hooks in element

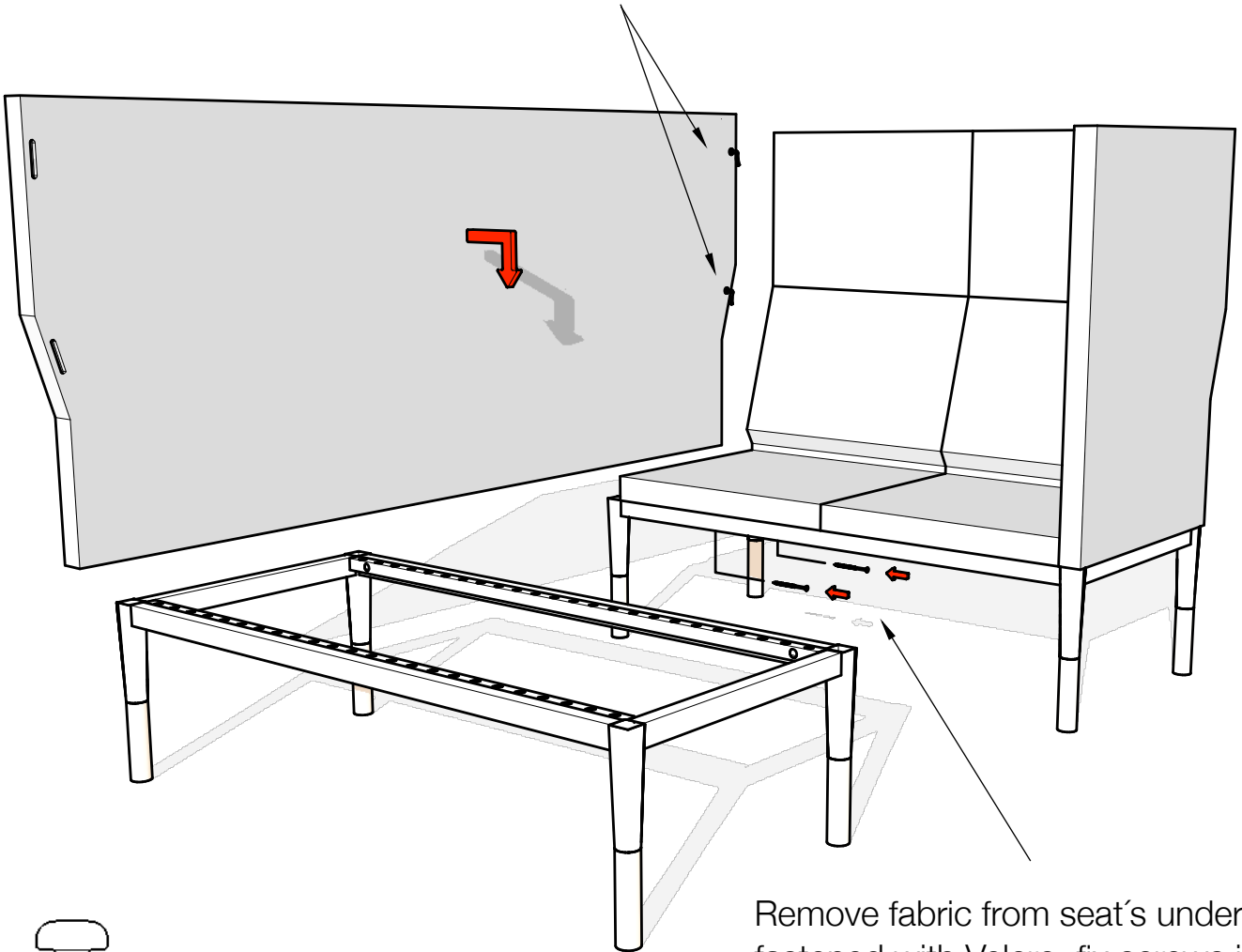

Remove fabric from seat's underside fastened with Velcro, fix screws into the wall, put back the fabric again.

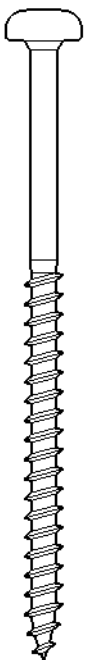

ø5 x 100 mm

JOHANSON

5

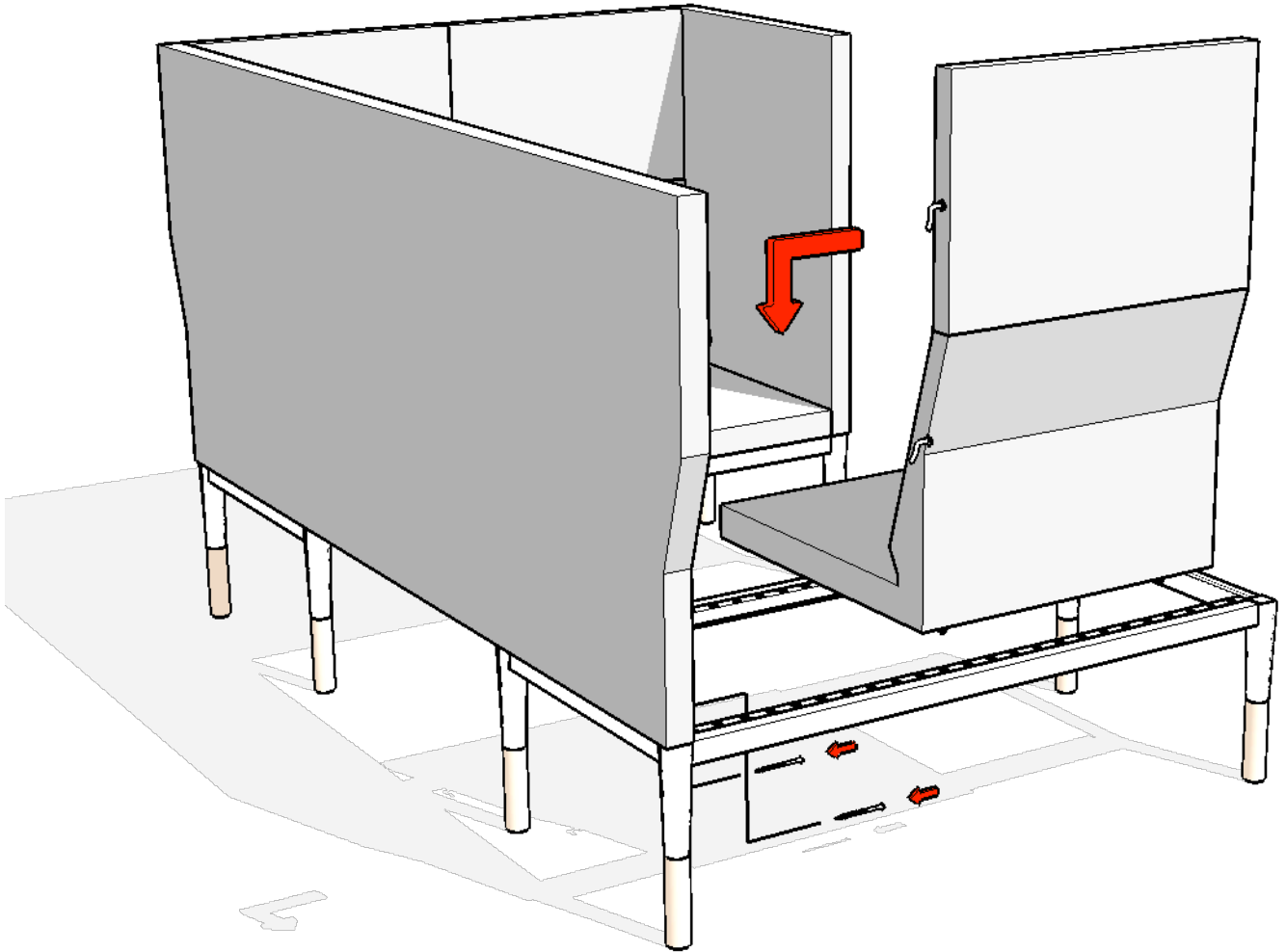

JOHANSON

6

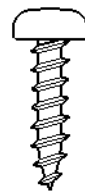
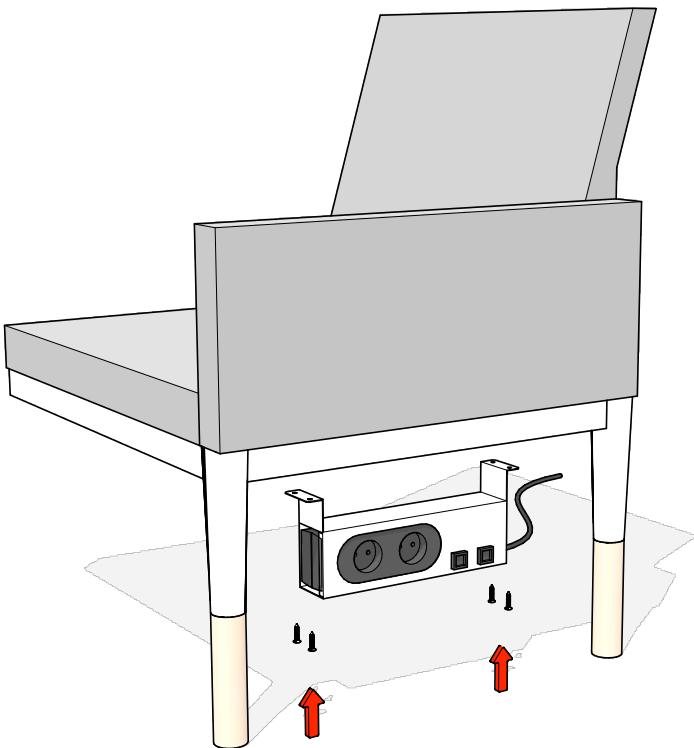
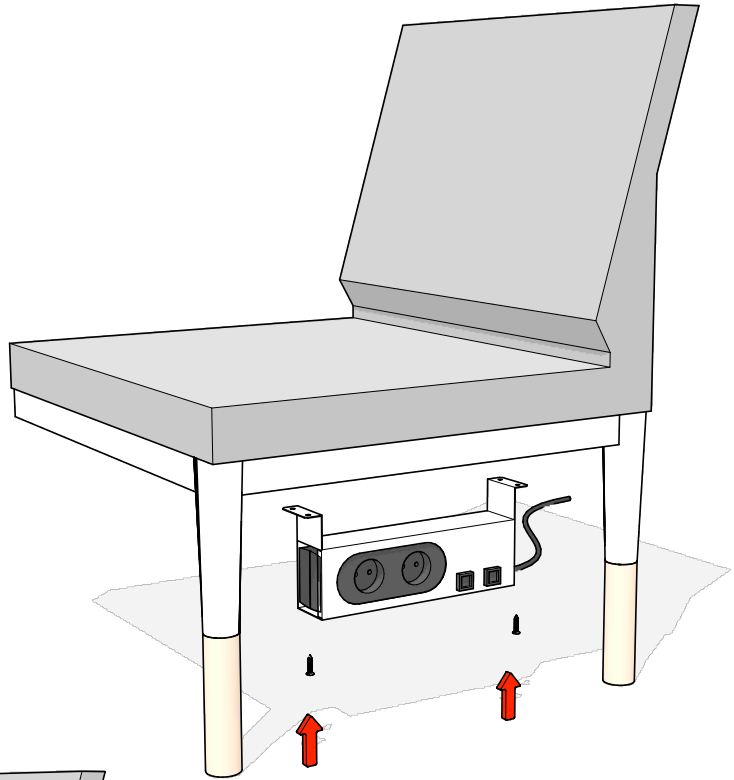

ø5 x 20 mm

JOHANSON